

# Leak Checker Prime

## Operating Manual



Version 2/13

# Contents

1.	Device description .....	3
1.1	Front view .....	3
1.2	Rear view.....	3
1.3	Accessories .....	4
2.	Commissioning.....	4
3.	Start measurement.....	5
3.1	Select one of the two programs: .....	7
3.2	Measurement is running.....	8
4.	Measurement results.....	8
5.	Set up program .....	10
6.	Select printer and edit print head.....	11
7.	Calibrating the touchscreen.....	12
8.	Cleaning the screen .....	13

# 1. Device description

## 1.1 Front view

1. Acrylic glass cover
2. Measuring head with sensor
3. Watch support
4. O-ring/seal
5. 5" touchscreen display

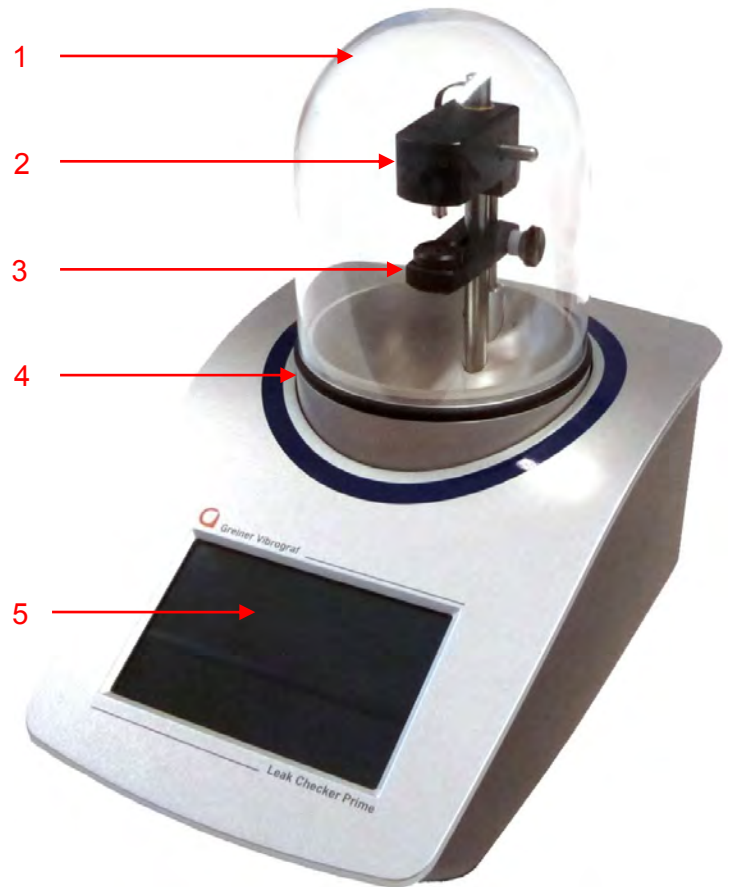

## 1.2 Rear view

6. USB-A
7. USB-B
8. Ethernet
9. RS 232
10. Mains power cable
11. ON/OFF switch

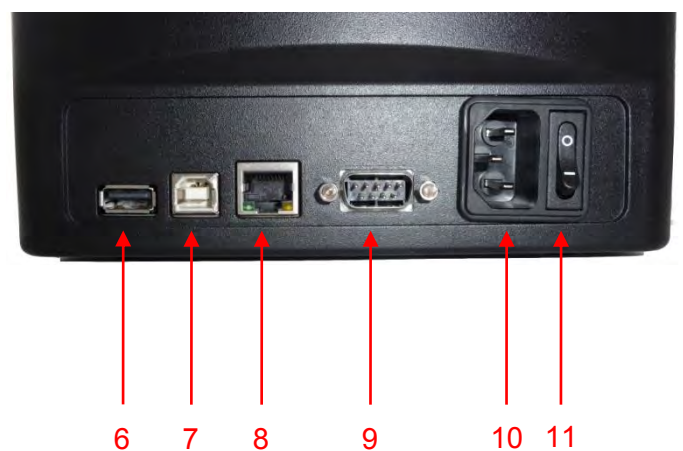

### 1.3 Accessories

- 12. Support for standard watches
- 13. Support for small watches and watches made of hard materials with ceramic case and sapphire crystal



## 2. Commissioning

1. Plug power cable into device and mains socket
2. Connect printer
3. Switch device on
4. Allow device to warm up for about 15 minutes
5. Start measurement

### 3. Start measurement

Press **Measuring**.

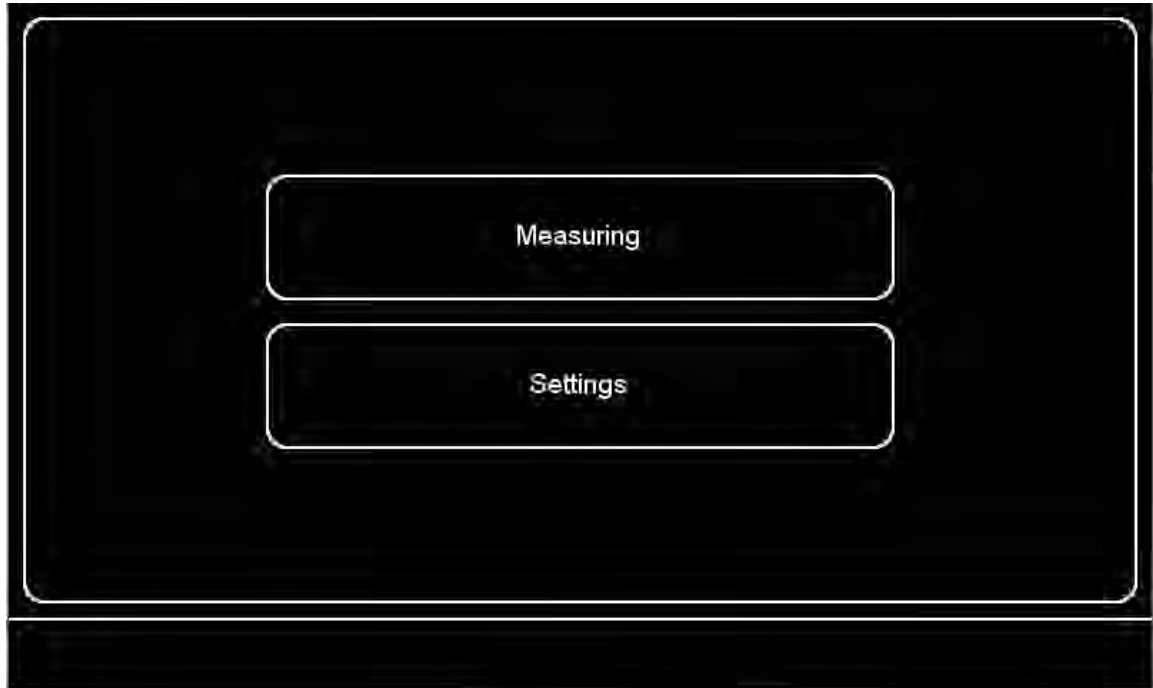

Insert the watch and move the measuring head vertically until all of the blue arrows have disappeared.

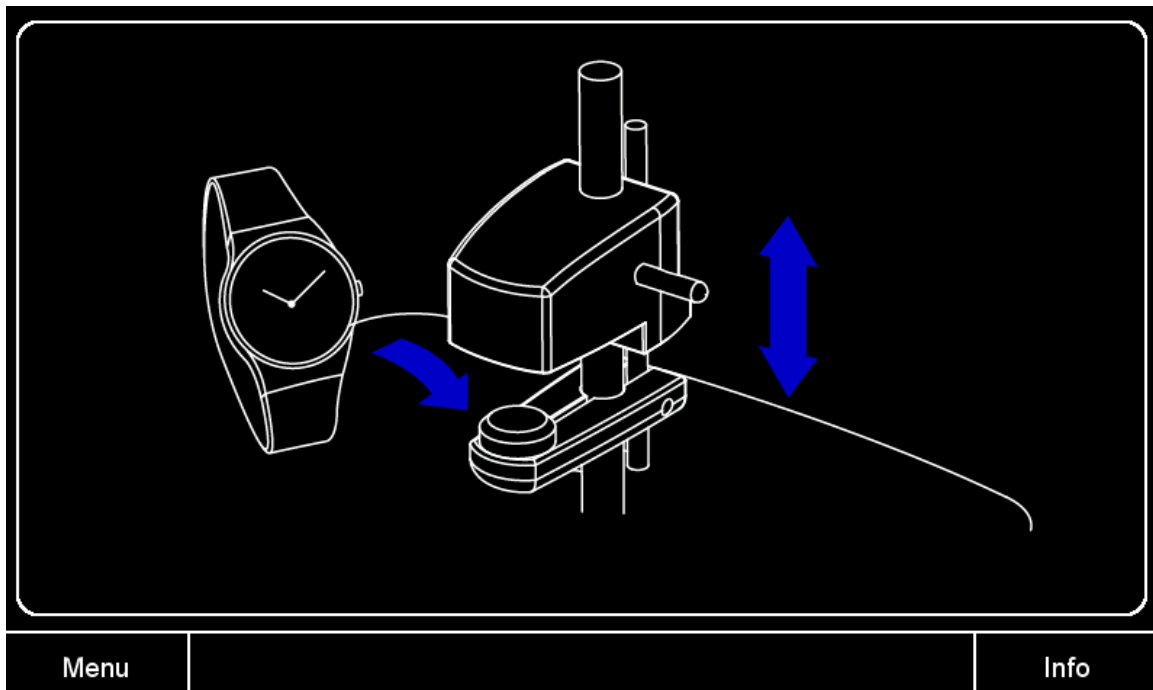

Move the measuring head vertically by simultaneously pulling on the lever and raising or lowering the measuring head as shown in the picture below.



If the watch does not fit correctly into the space, you can also move the watch support vertically by loosening the screw on the side.

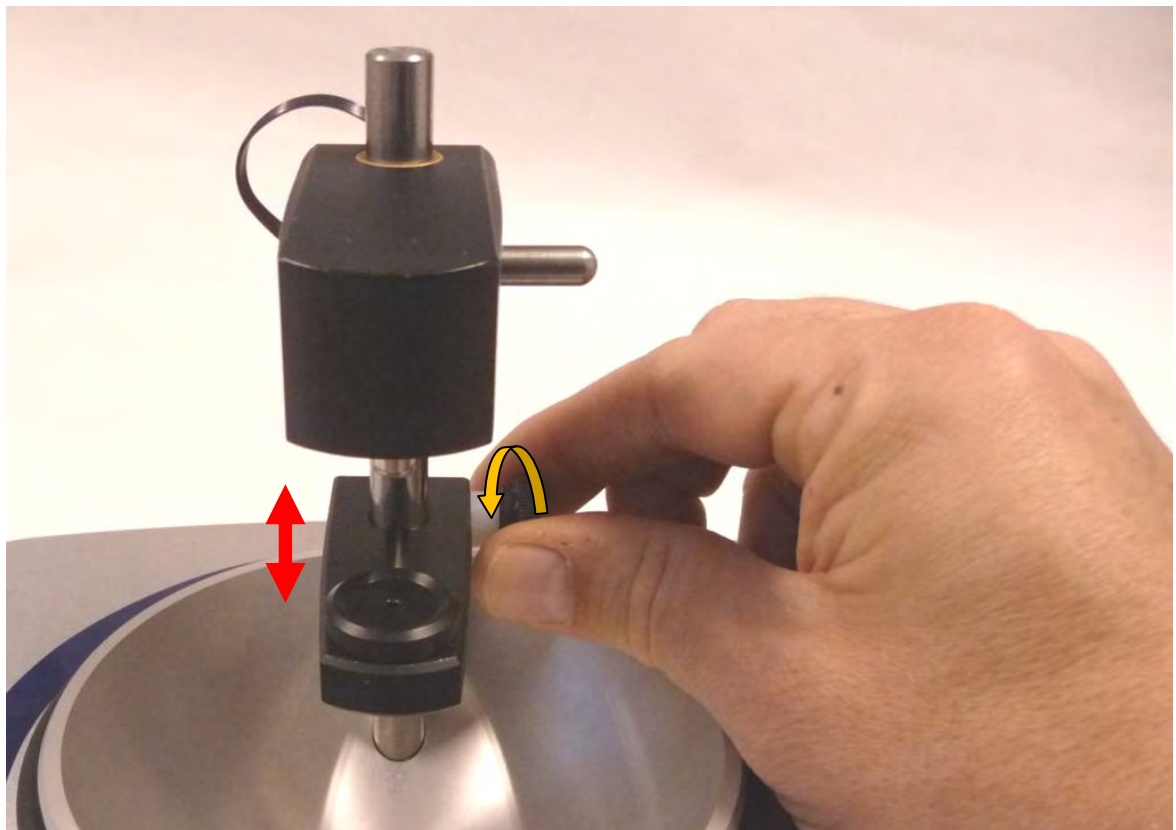

### 3.1 Select one of the two programs:

- **Start Auto** for automatic measurement.  
As soon as enough distortion is achieved, measurement starts.
- **Start X s / X Bar** for measurement with self-defined values.

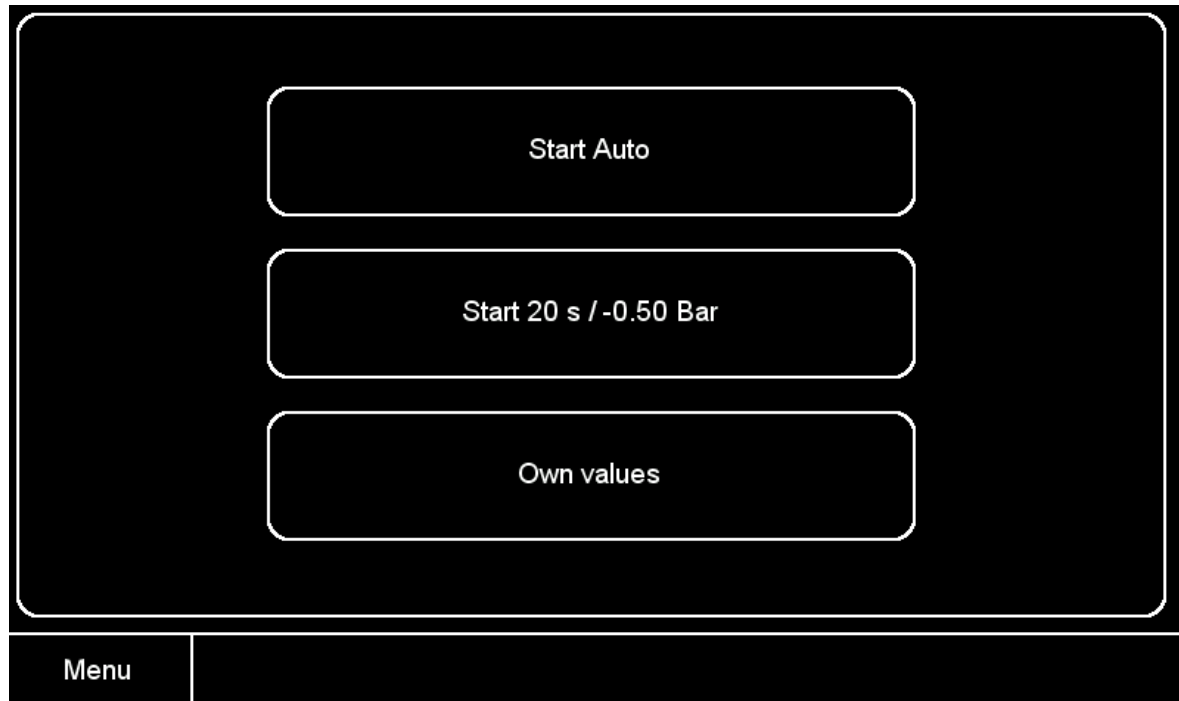

- With **Own values** you can adjust the values of the second program.  
See also: "Set up program"

### 3.2 Measurement is running...

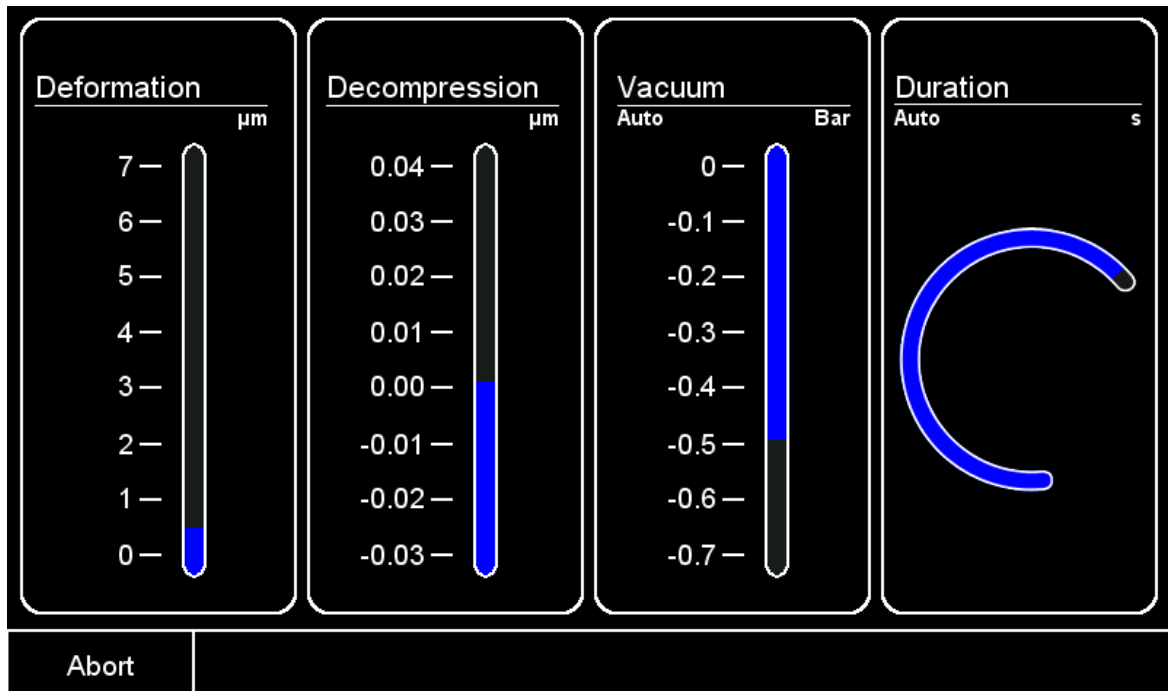

You can use **Abort** to interrupt the measurement at any time.

### 4. Measurement results

A green **ok** means the watch is waterproof.

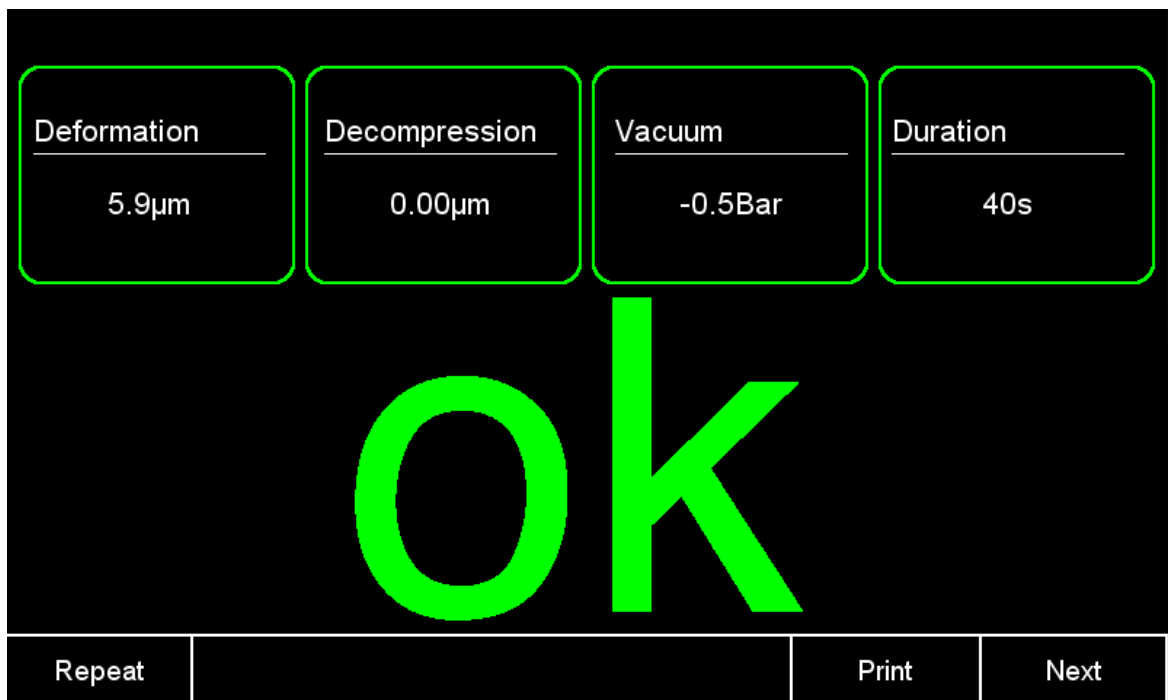



A red **no** means the watch is not waterproof

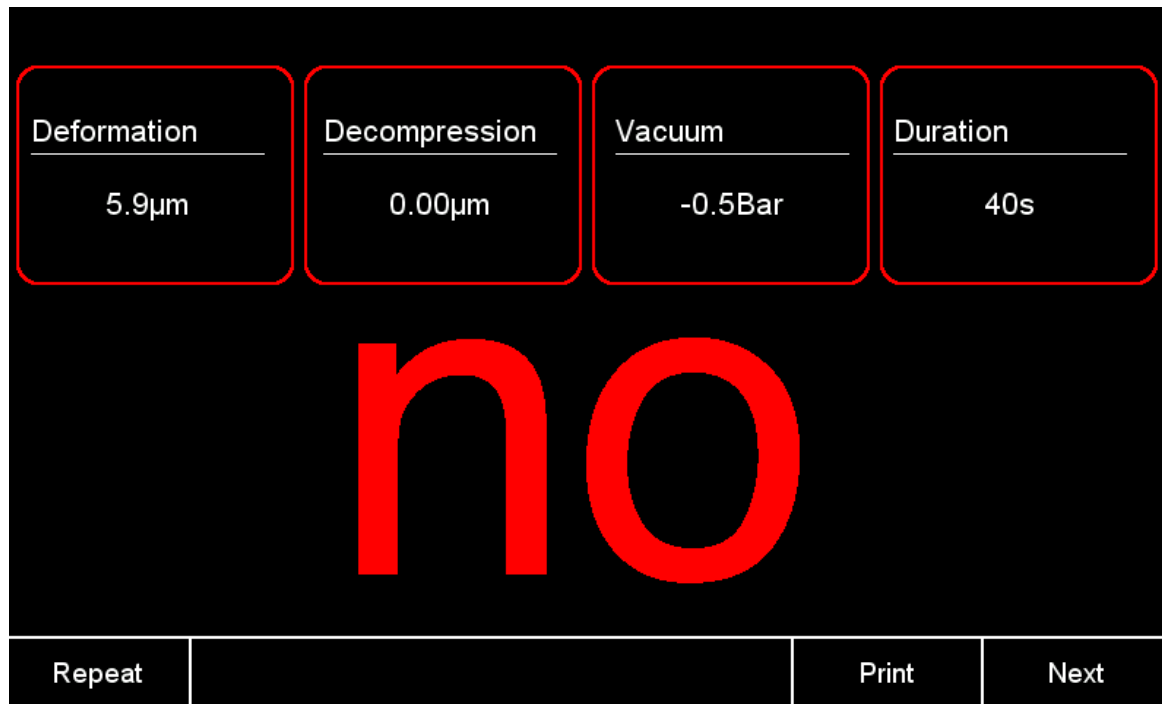

In both cases you can continue as follows:

- You can print out the results with **Print**.  
If printing does not work, please check you have selected the correct printer (see: Select printer)
- Selecting **Repeat** means the same measurement will be started again immediately.
- With **Next** you return to Select a measurement or the main menu.

## 5. Set up program

Press **Own values** to select your own values for the measurement.

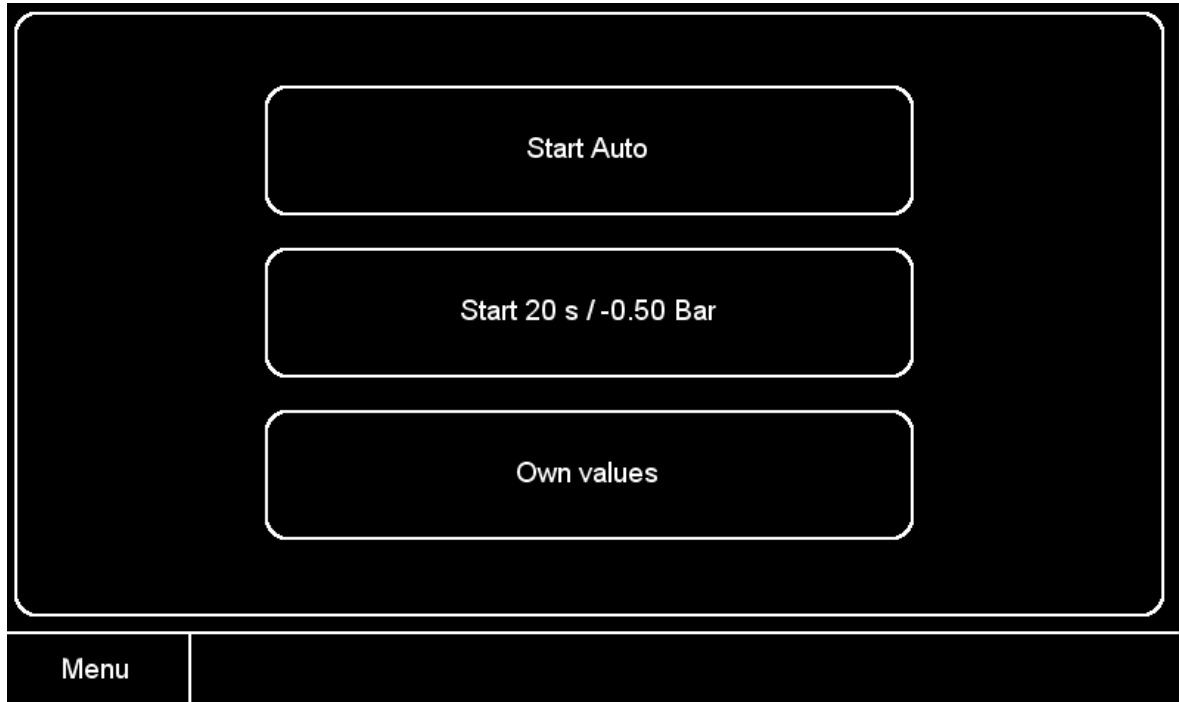

Now select the Measurement parameters by touching and dragging the controller that you want to adjust. Once you have set up the values to suit your requirements, press **Start** to begin measurement. The values you have selected are now saved for future measurements on the middle button in the Start menu.

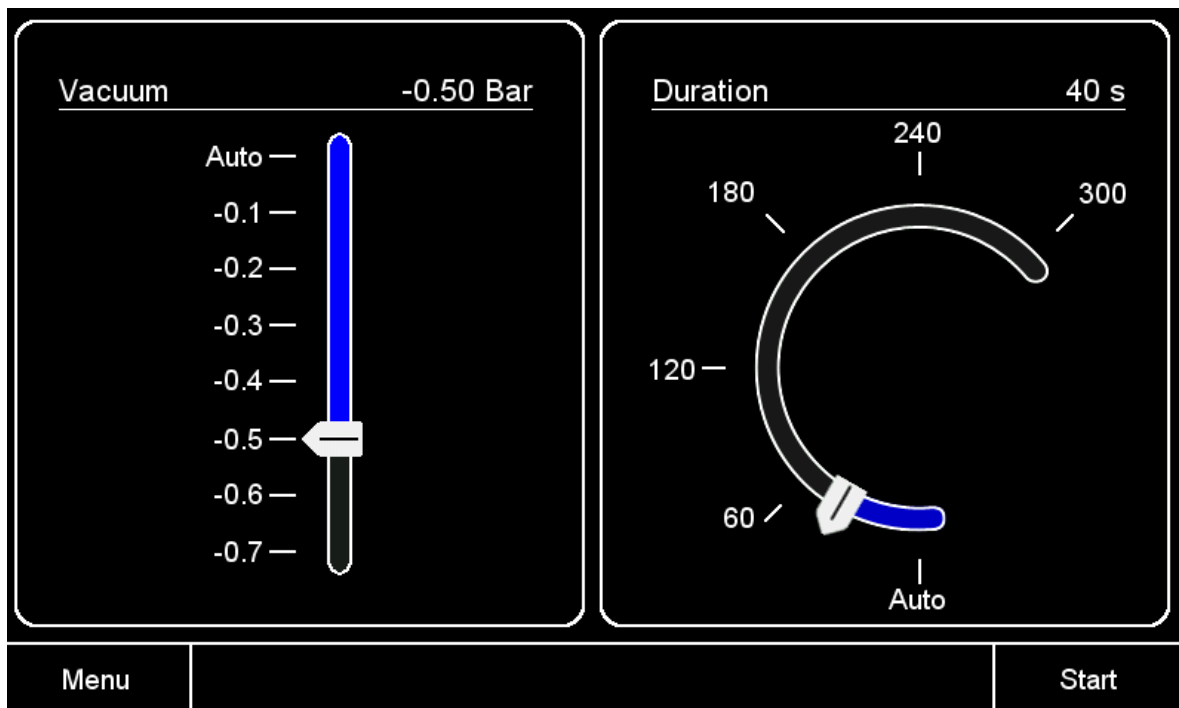

## 6. Select printer and edit print head

Press **Settings**.



Press **Printer** and select the printer that you have installed.

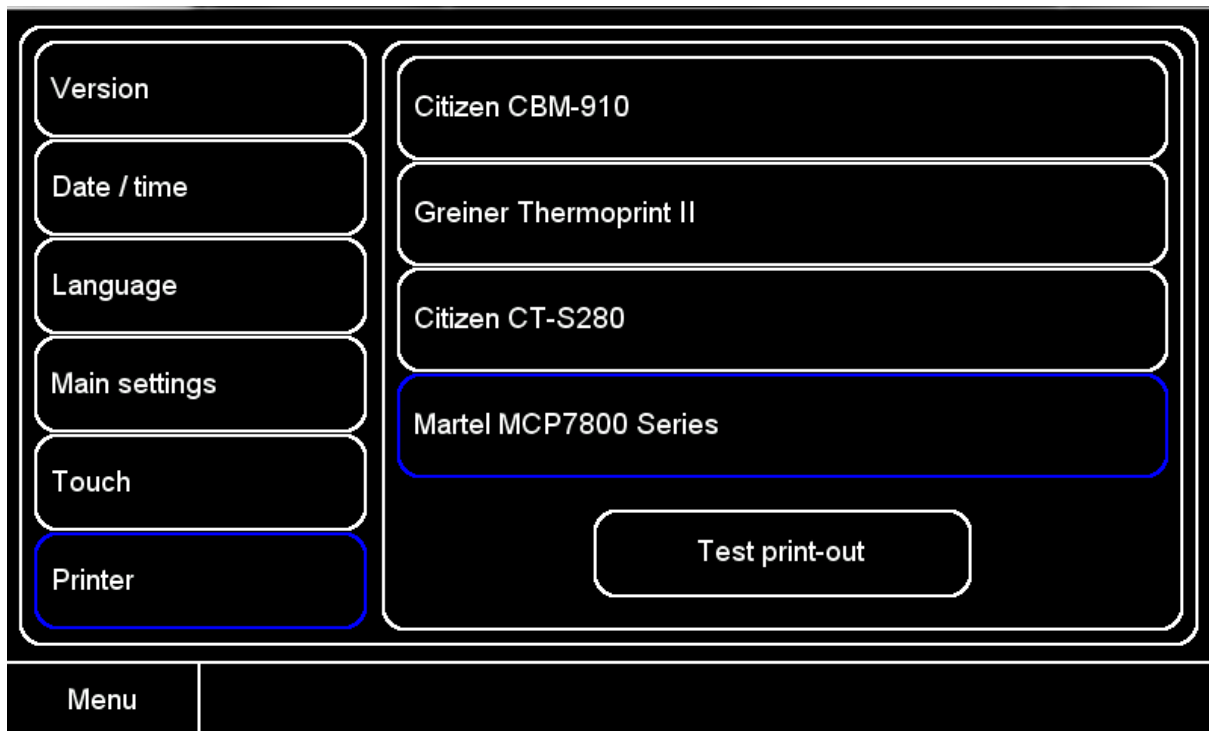

You can also select the **Printer head** menu to program your own company data for the print-out.



## 7. Calibrating the touchscreen

If you have the feeling that when pressing the buttons the field is out of alignment, you can calibrate the touchscreen. Press **Touch**, **Start calibration** and then use your finger to confirm the positions of the crosses.

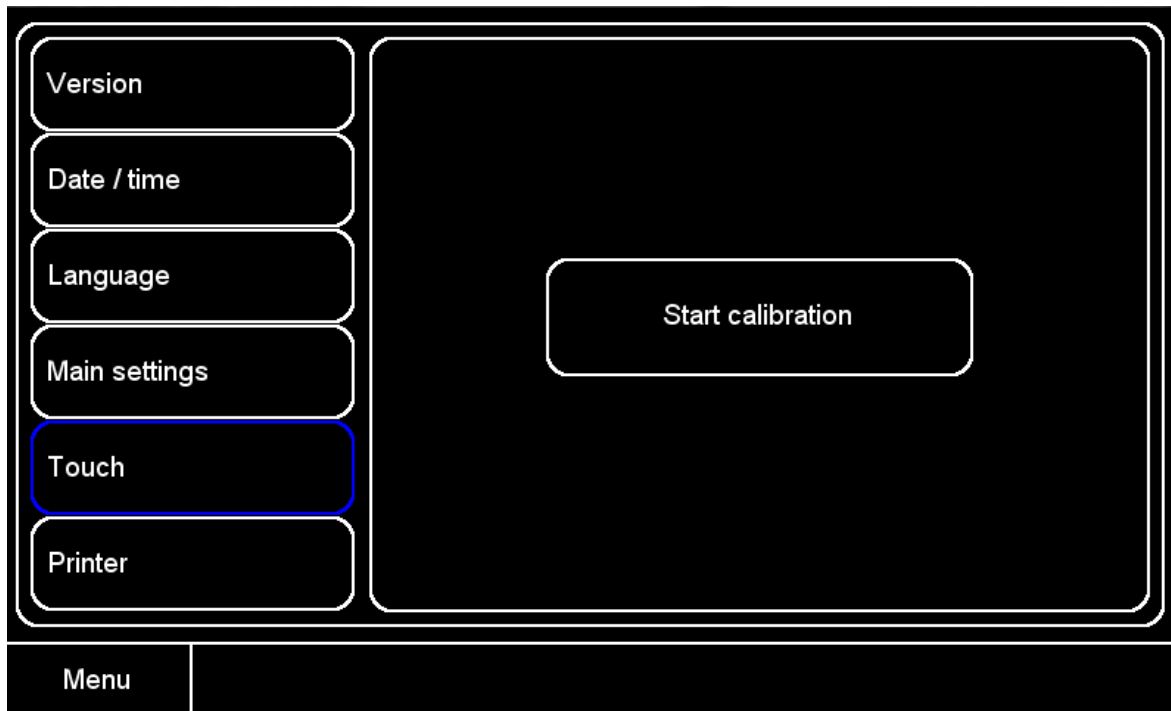

## **8. Cleaning the screen**

### **Before cleaning**

Only ever clean the screen once the device has been switched off and the screen surface has been allowed to cool down!

### **Remove dust**

Please use exclusively microfibre cloths or special screen cleaning cloths.

### **Cleaning the screen with a damp cloth**

Only ever use special screen cleaners.

Never spray the screen cleaner directly onto the monitor surface, but onto the cleaning cloth.

Never apply any pressure to the monitor surface when cleaning off marks and do not attempt to remove marks by scratching with your fingernail.

### **Drying the screen**

After cleaning with a damp cloth, dry off the user interface with a new microfibre cloth. Once you have finished cleaning, it is important to wait approximately 30 minutes before switching the device on again.